

mass integrated

global part distribution • product lifecycle partner
excess inventory management • value-ad service provider



Data sheet provided by Mass Integrated

massintegrated.com • displayalliance.com

Please call +1.978.465.6190
Email: sales@massintegrated.com



ISO 9001: 2008

Mass Integrated complies with all DMCA takedown notices. Please send a formal DMCA Takedown Notice to Mass Integrated Systems, Inc. • 18 Henry Graf Jr. Road, Unit 1 • Newburyport, MA 01950.

| | |
|--|--|
| Product Description: 65" Full HD Color TFT-LCD Module | |
| | |
| AUO Model Name: T645HW02 V1 | |
| Customer Part No. / Project Name: | |
| Customer Signature | AU Optronics Corp. |
| | Approved by: PM Head / Frank Hsu |
| | Reviewed by: RD Head / Hong-Jye Hong |
| | Reviewed by: Project Leader / Howard Yeh |
| | Prepared by: PM / Child Chiu |
| Note | |
| | |

Product Functional Specification

65" Full HD Color TFT-LCD Module Model Name: T645HW02 V1

(*) Preliminary Specification
() Final Specification

Note: This specification is subject to change without notice.

Contents

| No | |
|-----|-----------------------------------|
| | CONTENTS |
| | RECORD OF REVISIONS |
| 1 | GENERAL DESCRIPTION |
| 2 | ABSOLUTE MAXIMUM RATINGS |
| 3 | ELECTRICAL SPECIFICATION |
| 3.1 | SIGNAL ELECTRICAL CHARACTERISTICS |
| 3.2 | SIGNAL INTERFACE CONNECTOR |
| 3.3 | SIGNAL TIMING SPECIFICATION |
| 3.4 | SIGNAL TIMING WAVEFORM |
| 3.5 | COLOR INPUT DATA REFERENCE |
| 3.6 | BACK LIGHT POWER SPECIFICATION |
| 3.7 | POWER SEQUENCE |
| 4 | OPTICAL SPECIFICATION |
| 5 | MECHANICAL CHARACTERISTICS |
| 6 | PACKING |
| 7 | RELIABILITY TEST |
| 8 | INTERNATIONAL STANDARD |
| 9 | PRECAUTIONS |

1. General Description

This specification applies to the 65 inch Color TFT-LCD Module T645HW02 V1. This LCD module has a TFT active matrix type liquid crystal panel 1920x1080 pixels, and diagonal size of 64.5 inch. This module supports Full HD mode (non-interlace).

Each pixel is divided into Red, Green, and Blue sub-pixels or dots which are arranged in vertical stripes. Gray scale or the brightness of the sub-pixel color is determined by 8-bit gray scale signal for each dot.

The T645HW02 V1 has been designed to apply the 8-bit 4-channel LVDS interface method. It is intended to support displays where high brightness, wide viewing angle, double frame rate driving, and high color depth are important.

The T645HW02 V1 is RoHS verified which can be distinguished on panel label.

◆ General Information

| Items | Specification | Unit | Note |
|-------------------------|--------------------------------|--------|----------------------|
| Active Screen Size | 64.53 | inches | Diagonal |
| Display Area | 1428.48 (H) x 803.52 (V) | mm | |
| Outline Dimension | 1508.0(H) x 878.0(V) x 60.0(D) | mm | w/ Inverter Cover |
| Driver Element | a-Si TFT active matrix | | |
| Display Colors | 16.7M (8-bit) | colors | |
| Color Gamut | 72 | % | NTSC |
| Number of Pixels | 1920 x 1080 | pixel | |
| Pixel Arrangement | RGB vertical stripe | | |
| Pixel Pitch | 0.744 | mm | |
| Display Mode | Transmissive, Normally Black | | |
| Surface Treatment | HCLR, 3H | | |
| Total Power Consumption | (380) | watt | include BLU & Signal |
| Life Time (minimum) | 50,000 | hours | [1] |
| RoHS | RoHS compliance | | |

Note [1]: The life is determined as the time at which luminance of the lamp is 50% compared to that of initial value at the typical lamp current on condition of continuous operating at 25±2 °C.

2. Absolute Maximum Ratings

The followings are maximum values which, if exceeded, may cause faulty operation or damage to the unit:

| Item | Symbol | Min. | Max | Unit | Note |
|--------------------------------|------------|------|-------|------|------|
| Logic/LCD Drive Voltage | V_{CC} | -0.3 | +14.0 | V | [1] |
| Input Voltage of Signal | V_{IN} | -0.3 | +3.6 | V | [1] |
| BLU Input Voltage | V_{DDB} | -0.3 | +27.0 | V | [1] |
| BLU Brightness Control Voltage | V_{BLON} | -0.3 | +7.0 | V | [1] |
| Operating Temperature | T_{OP} | 0 | +50 | °C | [2] |
| Operating Humidity | H_{OP} | 10 | 90 | %RH | [2] |
| Storage Temperature | T_{ST} | -20 | +60 | °C | [2] |
| Storage Humidity | H_{ST} | 10 | 90 | %RH | [2] |
| Panel Surface Temperature | T_{SUR} | -- | +65 | °C | [2] |

Note [1]: If operate over spec but under absolute maximum rating, duration must be < 50ms.

Note [2]: Maximum Wet-Bulb should be 39°C and no condensation. The relative humidity must not exceed 80% non-condensing at temperatures of 40°C or less. At temperatures greater than 40°C, the wet bulb temperature must not exceed 39°C. When operate at low temperatures, the brightness of CCFL will drop and the life time of CCFL will be reduced.

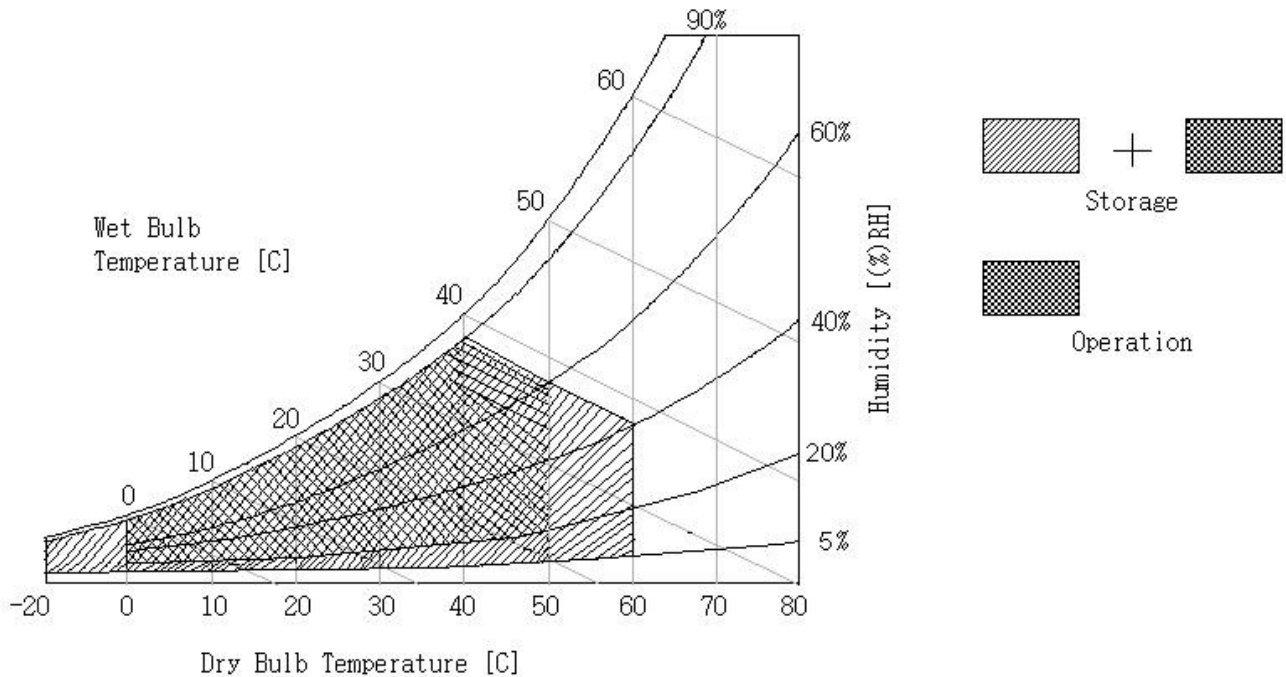

3. Electrical Specification

The T645HW02 V1 requires two power inputs. One is employed to power the LCD electronics and to drive the TFT array and liquid crystal. The second input is to power the inverter, which can power the CCFL.

3.1 Signal Electrical Characteristics

(Ta = 25 ± 2 °C)

| Parameter | | Symbol | Value | | | Unit | Note |
|----------------------------|---|------------------------|-------|------|------|------|------|
| | | | Min. | Typ. | Max | | |
| Power Supply Input Voltage | | V _{CC} | 10.8 | 12.0 | 13.2 | V | |
| Power Supply Input Current | | I _{CC} | | TBD | | A | [2] |
| Power Consumption | | P _{CC} | | TBD | | Watt | [2] |
| Inrush Current | | I _{RUSH} | -- | -- | TBD | A | [3] |
| LVDS Interface | Differential Input High Threshold Voltage | V _{TH} | -- | -- | +100 | mV | [4] |
| | Differential Input Low Threshold Voltage | V _{TL} | -100 | -- | -- | mV | [4] |
| | Common Input Voltage | V _{CIM} | 1.10 | 1.25 | 1.40 | V | |
| CMOS Interface | Input High Threshold Voltage | V _{IH} (High) | 2.4 | -- | 3.3 | V | |
| | Input Low Threshold Voltage | V _{IL} (Low) | 0 | -- | 0.7 | V | |

Note:

1. The check pattern is base on white pattern. The ripple voltage should be controlled under 10% of V_{CC}.
2. V_{CC} = 12.0V, F_V = 60Hz, F_{CLK} = 81.5Mhz, 25 °C, V_{CC} duration time = 470µs, test pattern: full white pattern
3. Measurement condition: rising time=470µs

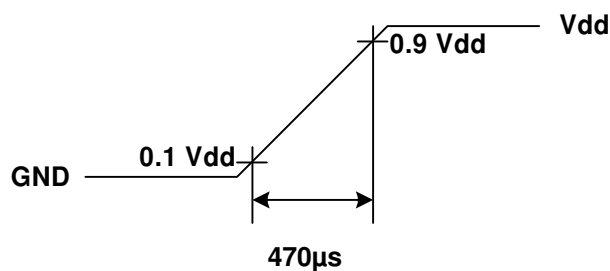

4. Measurement of LVDS differential voltage is shown as following:

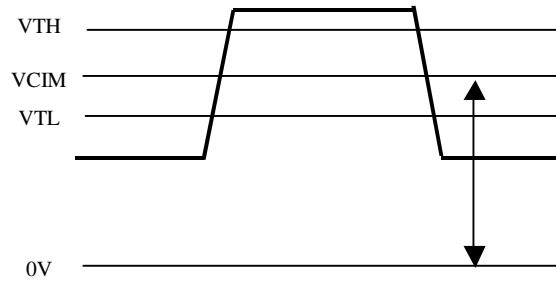

5. Do not attach a conducting tape to lamp connecting wire. If the lamp wire attach to conducting tape, TFT-LCD Module has a low luminance and the inverter has abnormal action because leakage current occurs between lamp wire and conducting tape.

3.2 Signal Interface Connections

◆ **LCD LVDS connector (41pin): JAE FI-RE41S-HF**

| PIN # | Signal Name | Description | Note |
|-------|-----------------|---|----------------|
| 1 | V _{CC} | Operating Voltage Supply, +12V DC Regulated | Power |
| 2 | V _{CC} | Operating Voltage Supply, +12V DC Regulated | |
| 3 | V _{CC} | Operating Voltage Supply, +12V DC Regulated | |
| 4 | V _{CC} | Operating Voltage Supply, +12V DC Regulated | |
| 5 | V _{CC} | Operating Voltage Supply, +12V DC Regulated | |
| 6 | GND | Ground | |
| 7 | GND | Ground | |
| 8 | GND | Ground | |
| 9 | GND | Ground | |
| 10 | R1_0- | LVDS Channel 1, Signal 0- | LVDS Channel 1 |
| 11 | R1_0+ | LVDS Channel 1, Signal 0+ | |
| 12 | R1_1- | LVDS Channel 1, Signal 1- | |
| 13 | R1_1+ | LVDS Channel 1, Signal 1+ | |
| 14 | R1_2- | LVDS Channel 1, Signal 2- | |
| 15 | R1_2+ | LVDS Channel 1, Signal 2+ | |
| 16 | GND | Ground | |
| 17 | R1_CLK- | LVDS Channel 1, Clock - | |
| 18 | R1_CLK+ | LVDS Channel 1, Clock + | |
| 19 | GND | Ground | |
| 20 | R1_3- | LVDS Channel 1, Signal 3- | |
| 21 | R1_3+ | LVDS Channel 1, Signal 3+ | |
| 22 | R1_4- | LVDS Channel 1, Signal 4- | |
| 23 | R1_4+ | LVDS Channel 1, Signal 4+ | |
| 24 | GND | Ground | |
| 25 | R3_0- | LVDS Channel 3, Signal 0- | LVDS Channel 3 |
| 26 | R3_0+ | LVDS Channel 3, Signal 0+ | |
| 27 | R3_1- | LVDS Channel 3, Signal 1- | |
| 28 | R3_1+ | LVDS Channel 3, Signal 1+ | |
| 29 | R3_2- | LVDS Channel 3, Signal 2- | |
| 30 | R3_2+ | LVDS Channel 3, Signal 2+ | |
| 31 | GND | Ground | |
| 32 | R3_CLK- | LVDS Channel 3, Clock - | |
| 33 | R3_CLK+ | LVDS Channel 3, Clock + | |
| 34 | GND | Ground | |

| PIN # | Signal Name | Description | Note |
|-------|-------------|------------------------------------|----------------|
| 35 | R3_3- | LVDS Channel 3, Signal 3- | LVDS Channel 3 |
| 36 | R3_3+ | LVDS Channel 3, Signal 3+ | |
| 37 | R3_4- | LVDS Channel 3, Signal 4- | |
| 38 | R3_4+ | LVDS Channel 3, Signal 4+ | |
| 39 | GND | Ground | |
| 40 | NC | No Connect (AUO Internal Use Only) | |
| 41 | NC | No Connect (AUO Internal Use Only) | |

◆ **LCD LVDS connector (51 pin): JAE FI-RE51S-HF**

| PIN # | Signal Name | Description | Note |
|-------|-----------------|---|----------------|
| 1 | V _{CC} | Operating Voltage Supply, +12V DC Regulated | Power |
| 2 | V _{CC} | Operating Voltage Supply, +12V DC Regulated | |
| 3 | V _{CC} | Operating Voltage Supply, +12V DC Regulated | |
| 4 | V _{CC} | Operating Voltage Supply, +12V DC Regulated | |
| 5 | V _{CC} | Operating Voltage Supply, +12V DC Regulated | |
| 6 | GND | Ground | |
| 7 | GND | Ground | |
| 8 | GND | Ground | |
| 9 | GND | Ground | |
| 10 | R2_0- | LVDS Channel 2, Signal 0- | LVDS Channel 2 |
| 11 | R2_0+ | LVDS Channel 2, Signal 0+ | |
| 12 | R2_1- | LVDS Channel 2, Signal 1- | |
| 13 | R2_1+ | LVDS Channel 2, Signal 1+ | |
| 14 | R2_2- | LVDS Channel 2, Signal 2- | |
| 15 | R2_2+ | LVDS Channel 2, Signal 2+ | |
| 16 | GND | Ground | |
| 17 | R2_CLK- | LVDS Channel 2, Clock - | |
| 18 | R2_CLK+ | LVDS Channel 2, Clock + | |
| 19 | GND | Ground | |
| 20 | R2_3- | LVDS Channel 2, Signal 3- | |
| 21 | R2_3+ | LVDS Channel 2, Signal 3+ | |
| 22 | R2_4- | LVDS Channel 2, Signal 4- | |
| 23 | R2_4+ | LVDS Channel 2, Signal 4+ | |
| 24 | GND | Ground | |

| PIN # | Signal Name | Description | Note |
|-------|-------------|--|-------------------|
| 25 | R4_0- | LVDS Channel 4, Signal 0- | LVDS Channel 4 |
| 26 | R4_0+ | LVDS Channel 4, Signal 0+ | |
| 27 | R4_1- | LVDS Channel 4, Signal 1- | |
| 28 | R4_1+ | LVDS Channel 4, Signal 1+ | |
| 29 | R4_2- | LVDS Channel 4, Signal 2- | |
| 30 | R4_2+ | LVDS Channel 4, Signal 2+ | |
| 31 | GND | Ground | |
| 32 | R4_CLK- | LVDS Channel 4, Clock - | |
| 33 | R4_CLK+ | LVDS Channel 4, Clock + | |
| 34 | GND | Ground | |
| 35 | R4_3- | LVDS Channel 4, Signal 3- | |
| 36 | R4_3+ | LVDS Channel 4, Signal 3+ | |
| 37 | R4_4- | LVDS Channel 4, Signal 4- | |
| 38 | R4_4+ | LVDS Channel 4, Signal 4+ | |
| 39 | GND | Ground | |
| 40 | NC | No Connect (AUO Internal Use Only) | |
| 41 | NC | No Connect (AUO Internal Use Only) | |
| 42 | NC | No Connect (AUO Internal Use Only) | |
| 43 | NC | No Connect (AUO Internal Use Only) | |
| 44 | NC | No Connect (AUO Internal Use Only) | |
| 45 | LVDS_SEL | Open/High(3.3V) for NS, Low(GND) for JEIDA | Default: NS |
| 46 | NC | No Connect (AUO Internal Use Only) | |
| 47 | NC | No Connect (AUO Internal Use Only) | |
| 48 | NC | No Connect (AUO Internal Use Only) | |
| 49 | NC | No Connect (AUO Internal Use Only) | |
| 50 | NC | No Connect (AUO Internal Use Only) | |
| 51 | NC | No Connect (AUO Internal Use Only) | |

Note [1]: All GND (ground) pins should be connected together and should also be connected to the LCD's metal frame.

Note [2]: All V_{CC} (power input) pins should be connected together.

Note [3]: All NC (no connection) pins should be open without voltage input.

◆ **LVDS Option = Open/High(3.3V) → NS**

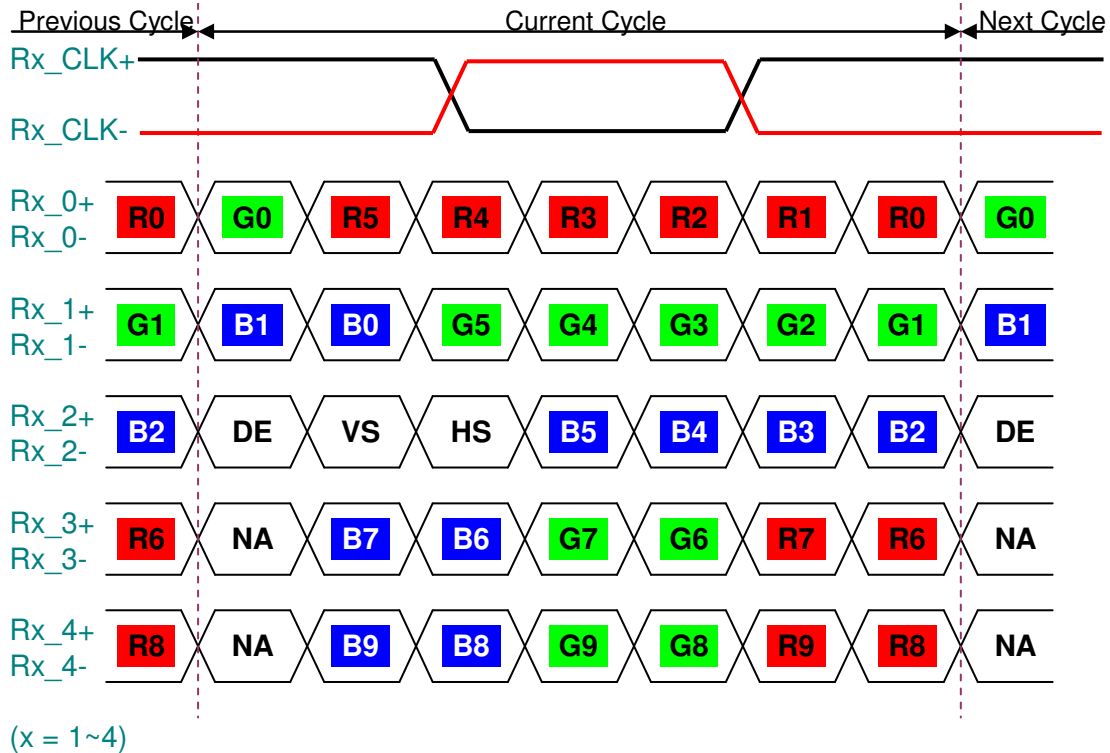

◆ **LVDS Option = Low(GND) → JEIDA**

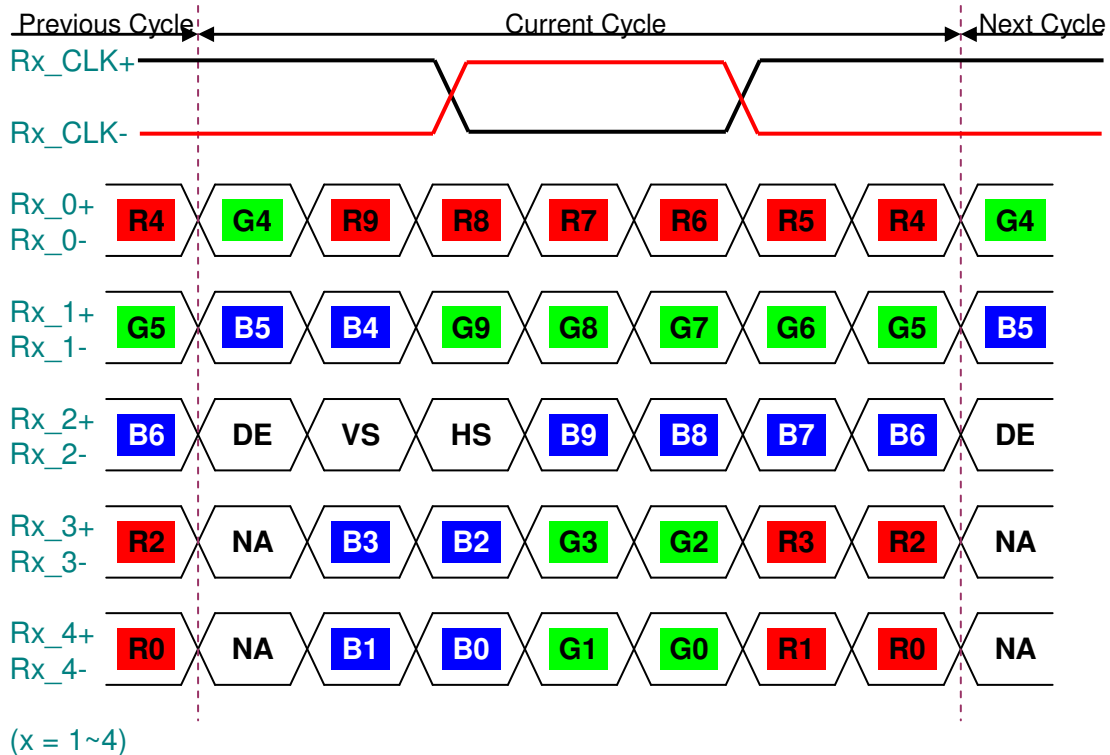

3.3 Signal Timing Specification

This is the signal timing required at the input of the user connector. All of the interface signal timing should be satisfied with the following specifications for its proper operation.

Timing Table (DE only Mode)

Vertical Frequency Range (120Hz)

| Signal | Item | Symbol | Min. | Typ. | Max | Unit |
|----------------------|-----------|----------------|--------|-------|-------|-----------|
| Vertical Section | Period | T_V | 1096 | 1130 | 1160 | T_H |
| | Active | $T_{DISP} (V)$ | 1080 | | | |
| | Blanking | $T_{BLK} (V)$ | 16 | 50 | 80 | T_H |
| Horizontal Section | Period | T_H | 560 | 570 | 580 | T_{CLK} |
| | Active | $T_{DISP} (H)$ | 480 | | | |
| | Blanking | $T_{BLK} (H)$ | 80 | 90 | 100 | T_{CLK} |
| Clock | Period | T_{CLK} | 13.58 | 12.94 | 12.39 | ns |
| | Frequency | F_{CLK} | 73.65 | 77.29 | 80.74 | MHz |
| Vertical Frequency | Frequency | F_V | 118 | 120 | 122 | Hz |
| Horizontal Frequency | Frequency | F_H | 131.52 | 135.6 | 139.2 | KHz |

3.4 Signal Timing Waveform

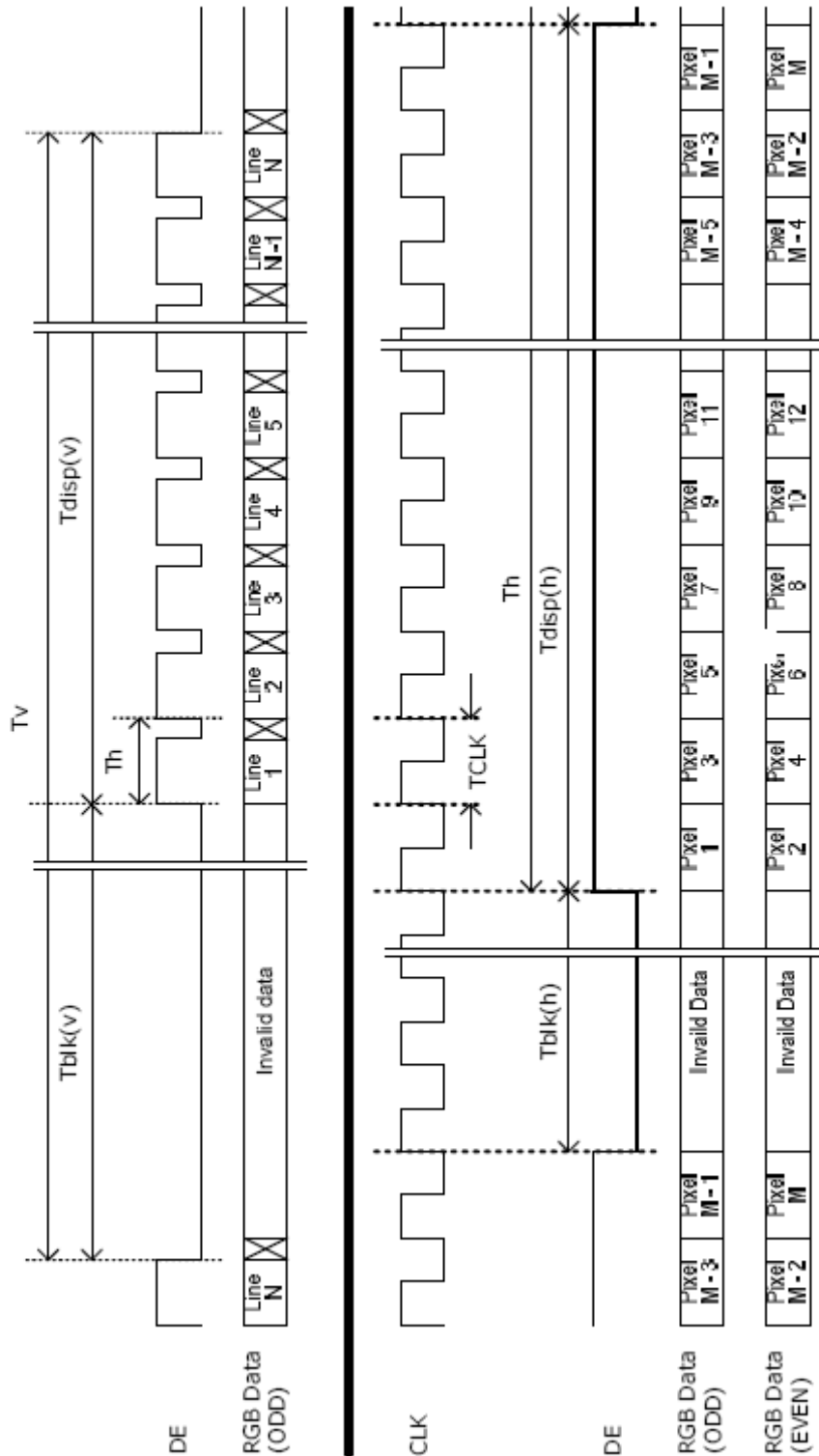

3.5 Color Input Data Reference

The brightness of each primary color (red, green, and blue) is based on the 8-bit gray scale data input for the color; the higher the binary input, the brighter the color. The table below provides a reference for color versus data input.

COLOR DATA REFERENCE

| Color | | Input Color Data | | | | | | | | | | | | | | | | | | | | | | | |
|-------------|------------|------------------|----|----|----|-----|----|----|----|-------|----|----|----|-----|----|----|----|------|----|----|----|-----|----|----|----|
| | | RED | | | | | | | | GREEN | | | | | | | | BLUE | | | | | | | |
| | | MSB | | | | LSB | | | | MSB | | | | LSB | | | | MSB | | | | LSB | | | |
| | | R7 | R6 | R5 | R4 | R3 | R2 | R1 | R0 | G7 | G6 | G5 | G4 | G3 | G2 | G1 | G0 | B7 | B6 | B5 | B4 | B3 | B2 | B1 | B0 |
| Basic Color | Black | 0 | 0 | 0 | 0 | 0 | 0 | 0 | 0 | 0 | 0 | 0 | 0 | 0 | 0 | 0 | 0 | 0 | 0 | 0 | 0 | 0 | 0 | 0 | 0 |
| | Red(255) | 1 | 1 | 1 | 1 | 1 | 1 | 1 | 1 | 0 | 0 | 0 | 0 | 0 | 0 | 0 | 0 | 0 | 0 | 0 | 0 | 0 | 0 | 0 | 0 |
| | Green(255) | 0 | 0 | 0 | 0 | 0 | 0 | 0 | 0 | 1 | 1 | 1 | 1 | 1 | 1 | 1 | 1 | 0 | 0 | 0 | 0 | 0 | 0 | 0 | 0 |
| | Blue(255) | 0 | 0 | 0 | 0 | 0 | 0 | 0 | 0 | 0 | 0 | 0 | 0 | 0 | 0 | 0 | 0 | 1 | 1 | 1 | 1 | 1 | 1 | 1 | 1 |
| | Cyan | 0 | 0 | 0 | 0 | 0 | 0 | 0 | 0 | 1 | 1 | 1 | 1 | 1 | 1 | 1 | 1 | 1 | 1 | 1 | 1 | 1 | 1 | 1 | 1 |
| | Magenta | 1 | 1 | 1 | 1 | 1 | 1 | 1 | 1 | 0 | 0 | 0 | 0 | 0 | 0 | 0 | 0 | 1 | 1 | 1 | 1 | 1 | 1 | 1 | 1 |
| | Yellow | 1 | 1 | 1 | 1 | 1 | 1 | 1 | 1 | 1 | 1 | 1 | 1 | 1 | 1 | 1 | 1 | 0 | 0 | 0 | 0 | 0 | 0 | 0 | 0 |
| | White | 1 | 1 | 1 | 1 | 1 | 1 | 1 | 1 | 1 | 1 | 1 | 1 | 1 | 1 | 1 | 1 | 1 | 1 | 1 | 1 | 1 | 1 | 1 | 1 |
| RED | RED(000) | 0 | 0 | 0 | 0 | 0 | 0 | 0 | 0 | 0 | 0 | 0 | 0 | 0 | 0 | 0 | 0 | 0 | 0 | 0 | 0 | 0 | 0 | 0 | 0 |
| | RED(001) | 0 | 0 | 0 | 0 | 0 | 0 | 0 | 1 | 0 | 0 | 0 | 0 | 0 | 0 | 0 | 0 | 0 | 0 | 0 | 0 | 0 | 0 | 0 | 0 |
| | ---- | | | | | | | | | | | | | | | | | | | | | | | | |
| | RED(254) | 1 | 1 | 1 | 1 | 1 | 1 | 1 | 0 | 0 | 0 | 0 | 0 | 0 | 0 | 0 | 0 | 0 | 0 | 0 | 0 | 0 | 0 | 0 | 0 |
| | RED(255) | 1 | 1 | 1 | 1 | 1 | 1 | 1 | 1 | 0 | 0 | 0 | 0 | 0 | 0 | 0 | 0 | 0 | 0 | 0 | 0 | 0 | 0 | 0 | 0 |
| GREEN | GREEN(000) | 0 | 0 | 0 | 0 | 0 | 0 | 0 | 0 | 0 | 0 | 0 | 0 | 0 | 0 | 0 | 0 | 0 | 0 | 0 | 0 | 0 | 0 | 0 | 0 |
| | GREEN(001) | 0 | 0 | 0 | 0 | 0 | 0 | 0 | 0 | 0 | 0 | 0 | 0 | 0 | 0 | 1 | 0 | 0 | 0 | 0 | 0 | 0 | 0 | 0 | 0 |
| | --- | | | | | | | | | | | | | | | | | | | | | | | | |
| | GREEN(254) | 0 | 0 | 0 | 0 | 0 | 0 | 0 | 0 | 1 | 1 | 1 | 1 | 1 | 1 | 1 | 0 | 0 | 0 | 0 | 0 | 0 | 0 | 0 | 0 |
| | GREEN(255) | 0 | 0 | 0 | 0 | 0 | 0 | 0 | 0 | 1 | 1 | 1 | 1 | 1 | 1 | 1 | 1 | 0 | 0 | 0 | 0 | 0 | 0 | 0 | 0 |
| BLUE | BLUE(000) | 0 | 0 | 0 | 0 | 0 | 0 | 0 | 0 | 0 | 0 | 0 | 0 | 0 | 0 | 0 | 0 | 0 | 0 | 0 | 0 | 0 | 0 | 0 | 0 |
| | BLUE(001) | 0 | 0 | 0 | 0 | 0 | 0 | 0 | 0 | 0 | 0 | 0 | 0 | 0 | 0 | 0 | 0 | 0 | 0 | 0 | 0 | 0 | 0 | 0 | 1 |
| | ----- | | | | | | | | | | | | | | | | | | | | | | | | |
| | BLUE(254) | 0 | 0 | 0 | 0 | 0 | 0 | 0 | 0 | 0 | 0 | 0 | 0 | 0 | 0 | 0 | 0 | 1 | 1 | 1 | 1 | 1 | 1 | 1 | 0 |
| | BLUE(255) | 0 | 0 | 0 | 0 | 0 | 0 | 0 | 0 | 0 | 0 | 0 | 0 | 0 | 0 | 0 | 0 | 1 | 1 | 1 | 1 | 1 | 1 | 1 | 1 |

3.6 Backlight Power Specification

◆ Electrical Specification

(Ta=25±5°C, Turn-on after 60mins)

| | Item | Symbol | Specification | | | Unit | Note |
|---|--------------------------|------------------|---------------|------|-----|-------------------|-------------|
| | | | Min. | Typ. | Max | | |
| 1 | High Voltage (HV) Input | HV1/ HV2 | TBD | TBD | TBD | V _{RMS} | |
| 2 | Input Current of ech HV | I _{HV} | TBD | TBD | TBD | mA _{RMS} | |
| 3 | High Voltage (HV) Output | V _{OUT} | TBD | TBD | TBD | V _{RMS} | |
| 4 | Output Lamp Current | I _{OUT} | 8.0 | 8.5 | 9.0 | mA _{RMS} | PWM=100% |
| 5 | Operating Frequency | F _{OP} | 43 | 45 | 47 | KHz | (Recommend) |
| 6 | PWM Dimming Frequency | F _{PWM} | 140 | 180 | 240 | Hz | (Recommend) |
| 7 | Dimming Duty Ratio | D _{PWM} | 30 | | 100 | % | (Recommend) |
| 8 | Lamp Type | | Straight | | | | |
| 9 | Number of Lamps | | 26 | | | pcs | |

Protection Circuit (Feedback Signal):

| | | | | | | | |
|----|-------------------------|--------------------|----------------------|-----|-----------------|------------------|------------------------|
| 10 | Supply Voltage | V _{CC} | - | TBD | - | V _{DC} | |
| 11 | Supply Current | I _{CC} | | TBD | | mA _{DC} | |
| 12 | Current Feedback Signal | V _{FB} | | TBD | | V _{RMS} | |
| 13 | Lamp Detection (OLP) | V _{LD(H)} | V _{CC} -0.5 | | V _{CC} | V _{DC} | Lamp normal status |
| | | V _{LD(L)} | | | 0.8 | V _{DC} | Lamp protection status |

Lamp Specification:

| | | | | | | | |
|----|------------------------|-------------------|-----|-----|-----|-------------------|--------------------------------------|
| 14 | Output Working Voltage | V _L | TBD | TBD | TBD | V _{RMS} | I _L =6.0mA _{RMS} |
| 15 | Output Current | I _L | 8.0 | 8.5 | 9.0 | mA _{RMS} | |
| 16 | Lamp Frequency | F _{LAMP} | 43 | 45 | 47 | KHz | |
| 17 | Starting Voltage | V _S | - | - | - | V _{RMS} | Ta=25°C(參考燈管 SPC.) |

◆ **Inverter Interface Connection**

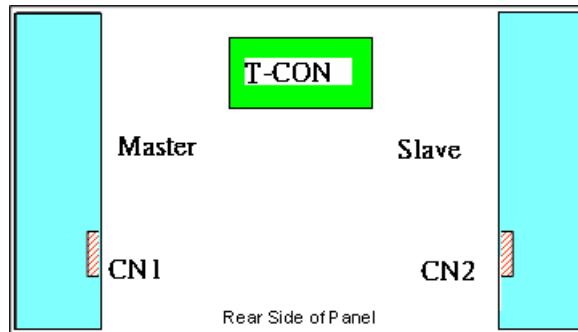

CN1: Civlux_CI0114M1HRL-NH

| PIN # | Symbol | Description |
|-------|--------------------|---|
| 1 | V _{DDB} | Operating Voltage Supply, +24V DC Regulated |
| 2 | V _{DDB} | Operating Voltage Supply, +24V DC Regulated |
| 3 | V _{DDB} | Operating Voltage Supply, +24V DC Regulated |
| 4 | V _{DDB} | Operating Voltage Supply, +24V DC Regulated |
| 5 | V _{DDB} | Operating Voltage Supply, +24V DC Regulated |
| 6 | GND | Ground |
| 7 | GND | Ground |
| 8 | GND | Ground |
| 9 | GND | Ground |
| 10 | GND | Ground |
| 11 | Det | Normal display: ($\leq 0.8V$), Fail: open collector |
| 12 | VBLON | BL On-Off: High (3.3~5V) for BL On , Low/Open (GND) for off |
| 13 | Internal PWM(VDIM) | Internal PWM Dimming High (3.3V/100% Duty) for 100% Lum; <NC; when external PWM> |
| 14 | External PWM(PDIM) | External PWM Dimming (30%~100% Duty) ; <NC; when internal PWM> |

Note (1) Det is Output pin for detect power error. When backlight is normal operation, DET is GND(0V). When backlight is abnormal, DET is high(5V).

Note (2) PWM dimming function is included internal PWM and external PWM.

Internal PWM: input voltage 0 (GND) ~3.3V to pin 13th, and duty ratio of output voltage/current of inverter is from 30% to 100%. When use pin 13th to control backlight luminance, the pin 14th will be NC and can not be affect by noise!

External PWM: input duty ratio 30% ~100% to pin 14th, and duty ratio of output voltage/current of inverter is from 30% to 100%. When use pin 14th to control backlight luminance, the pin 13th will be NC and can not be affect by noise!

Pin 13th and pin 14th can not be used at the same time!

CN2: Civilux_CI0114M1HRL-NH

| PIN # | Symbol | Description |
|-------|------------------|---|
| 1 | V _{DDB} | Operating Voltage Supply, +24V DC Regulated |
| 2 | V _{DDB} | Operating Voltage Supply, +24V DC Regulated |
| 3 | V _{DDB} | Operating Voltage Supply, +24V DC Regulated |
| 4 | V _{DDB} | Operating Voltage Supply, +24V DC Regulated |
| 5 | V _{DDB} | Operating Voltage Supply, +24V DC Regulated |
| 6 | GND | Ground |
| 7 | GND | Ground |
| 8 | GND | Ground |
| 9 | GND | Ground |
| 10 | GND | Ground |
| 11 | NC | No Connect |
| 12 | NC | No Connect |
| 13 | NC | No Connect |
| 14 | NC | No Connect |

Note [3]: All GND (ground) pins for all 4 connectors should be connected together and should also be connected to the LCD's metal frame.

Note [4]: All V_{DDB} (power input) pins for all 4 connectors should be connected together.

Note [5]: All NC (no connection) pins should be open without voltage input.

3.7 Power Sequence

◆ Power Sequence of LCD

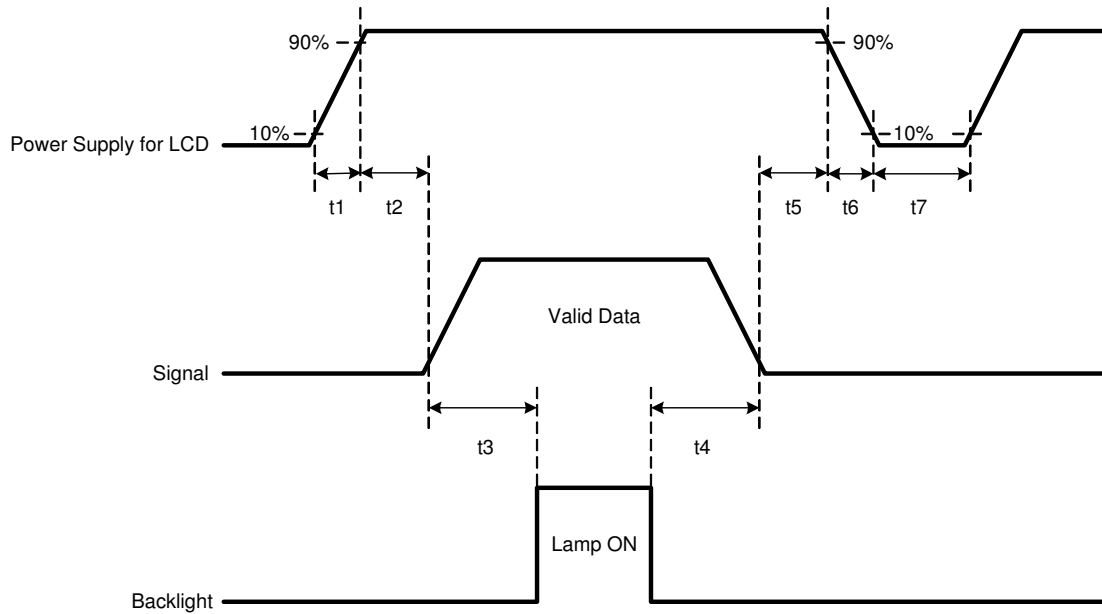

| Parameter | Values | | | Unit |
|-----------|--------|------|------|------|
| | Min. | Typ. | Max. | |
| t1 | 0.4 | -- | 30 | ms |
| t2 | 0.1 | -- | 50 | ms |
| t3 | 300 | -- | -- | ms |
| t4 | 10 | -- | -- | ms |
| t5 | 0.1 | -- | 50 | ms |
| t6 | -- | -- | 300 | ms |
| t7 | 500 | -- | -- | ms |

Apply the lamp voltage within the LCD operating range. When the backlight turns on before the LCD operation or the LCD turns off before the backlight turns off, the display may momentarily become abnormal.

Caution: The above on/off sequence should be applied to avoid abnormal function in the display. In case of handling, make sure to turn off the power when you plug the cable into the input connector or pull the cable out of the connector.

◆ **Power Sequence of Inverter**

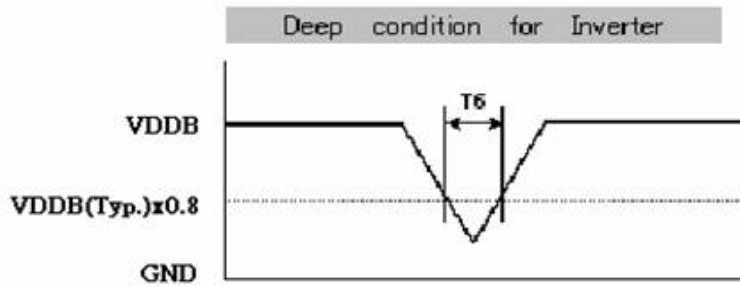
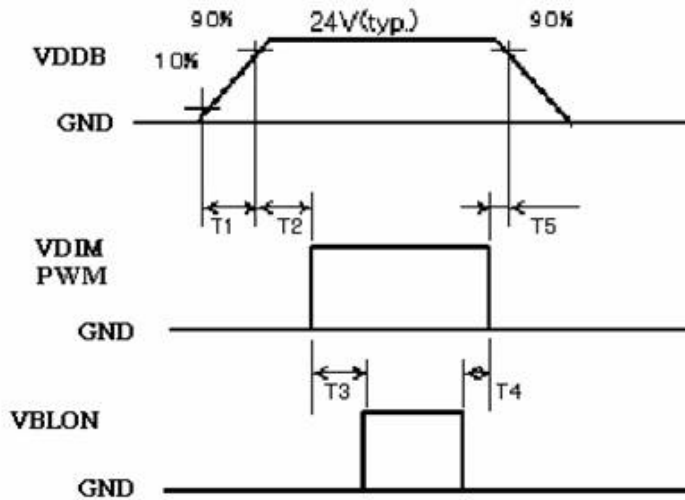

| Parameter | Values | | | Unit |
|-----------|--------|------|------|------|
| | Min. | Typ. | Max. | |
| T1 | 20 | -- | -- | ms |
| T2 | 500 | -- | -- | ms |
| T3 | 250 | -- | -- | ms |
| T4 | 0 | -- | -- | ms |
| T5 | 1 | -- | 50 | ms |
| T6 | -- | -- | 10 | ms |

4. Optical Specification

Optical characteristics are determined after the unit has been 'ON' and stable for approximately 60 minutes in a dark environment at 25°C. The values specified are at an approximate distance 50cm from the LCD surface at a viewing angle of φ and θ equal to 0°.

Test condition:

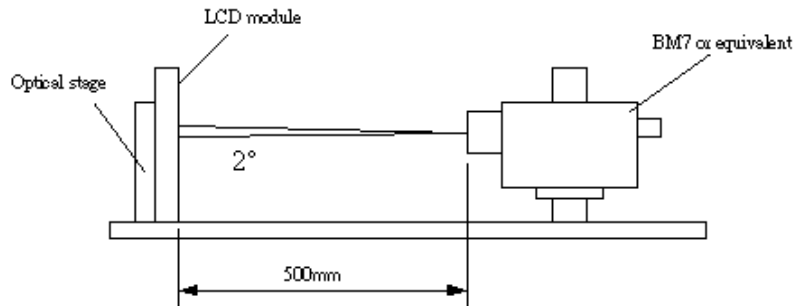

($T_a=25\pm 5^\circ\text{C}$, Turn-on after 60mins)

| Parameter | Symbol | Values | | | Unit | Notes |
|--------------------------------------|----------------------|-----------|------|-----------|-----------------|------------------------|
| | | Min. | Typ. | Max | | |
| Contrast Ratio | CR | 4000 | 5000 | -- | | [1], [2] |
| Surface Luminance (White) | L_{WH} | 400 | 500 | -- | cd/m^2 | [1], [3] |
| Luminance Variation | $\delta_{WHITE(9P)}$ | -- | -- | 1.3 | | [4] |
| Response Time (Average) | T_R | -- | 5.5 | -- | ms | [1],[5] (Gray to Gray) |
| Color Coordinates | | | | | | (CIE 1931) |
| Red | R_x | Typ.-0.03 | 0.64 | Typ.+0.03 | | [1] |
| | R_y | | 0.33 | | | [1] |
| Green | G_x | | 0.29 | | | [1] |
| | G_y | | 0.60 | | | [1] |
| Blue | B_x | | 0.15 | | | [1] |
| | B_y | | 0.06 | | | [1] |
| White | W_x | | 0.28 | | | [1] |
| | W_y | | 0.29 | | | [1] |
| Viewing Angle | | | | | | (Contrast Ratio>10) |
| x axis, right($\varphi=0^\circ$) | θ_r | -- | 89 | -- | degree | [1], [6] |
| x axis, left($\varphi=180^\circ$) | θ_l | -- | 89 | -- | degree | [1], [6] |
| y axis, up($\varphi=90^\circ$) | θ_u | -- | 89 | -- | degree | [1], [6] |
| y axis, down ($\varphi=270^\circ$) | θ_d | -- | 89 | -- | degree | [1], [6] |

Note [1]: The values of contrast ratio, surface luminance, response time, color coordinates, and viewing angle are measured at center point of display area.

Note [2]: Contrast Ratio (CR) is defined mathematically as:

$$\text{Contrast Ratio (CR)} = \frac{\text{Brightness of 'full white' state}}{\text{Brightness of 'full black' state}}$$

Note [3]: Surface Luminance is luminance value at center point of display area, 50cm from the surface with all pixels displaying white.

Note [4]: The variation in surface luminance, $\delta_{\text{WHITE(9P)}}$ is defined as:

$$\delta_{\text{WHITE(9P)}} = \text{Maximum}(L_{\text{on1}}, L_{\text{on2}}, \dots, L_{\text{on9}}) / \text{Minimum}(L_{\text{on1}}, L_{\text{on2}}, \dots, L_{\text{on9}})$$

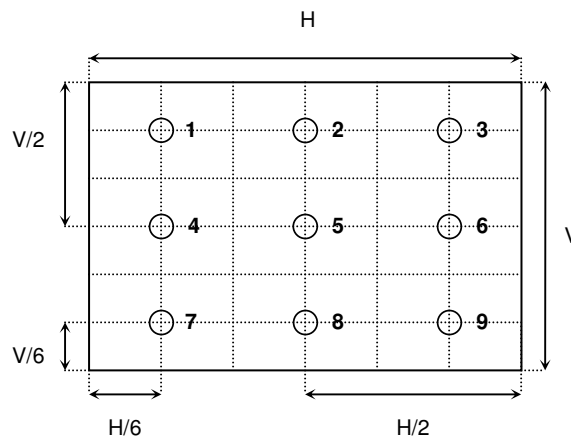

Note [5]: Response time TR is the average time required for display transition by switching the input signal for five luminance ratio (0%, 25%, 50%, 75%, 100% brightness matrix) and is based on $F_V = 60\text{Hz}$ to optimize.

| | 0% | 25% | 50% | 75% | 100% |
|------|-----------|------------|------------|------------|------------|
| 0% | | t:0%-25% | t:0%-50% | t:0%-75% | t:0%-100% |
| 25% | t:25%-0% | | t:25%-50% | t:25%-75% | t:25%-100% |
| 50% | t:50%-0% | t:50%-25% | | t:50%-75% | t:50%-100% |
| 75% | t:75%-0% | t:75%-25% | t:75%-50% | | t:50%-100% |
| 100% | t:100%-0% | t:100%-25% | t:100%-50% | t:100%-75% | |

Note [6]: Viewing angle is the angle at which the contrast ratio is greater than 10. The angles are determined for the horizontal (or x-axis) and the vertical (or y-axis) with respect to the z-axis which is normal to the LCD surface.

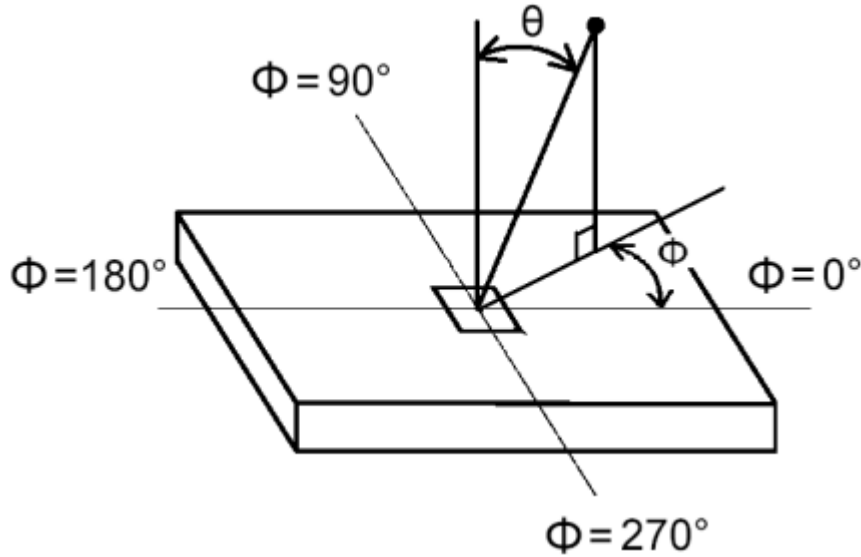

5. Mechanical Characteristics

The contents provide general mechanical characteristics for the model T645HW01 V0. Detailed mechanical drawings are shown in the following pages.

| | | |
|---------------------|-------------------|-------------------------|
| Outline Dimension | Horizontal (typ.) | 1508.0 mm |
| | Vertical (typ.) | 878.0 mm |
| | Depth (typ.) | 60.0 mm (with inverter) |
| Bezel Opening Area | Horizontal (typ.) | 1440.6 mm |
| | Vertical (typ.) | 814.6 mm |
| Active Display Area | Horizontal | 1428.48 mm |
| | Vertical | 803.52 mm |
| Weight | 33 KG (Max) | |

2D Drawing (Front) - Draft

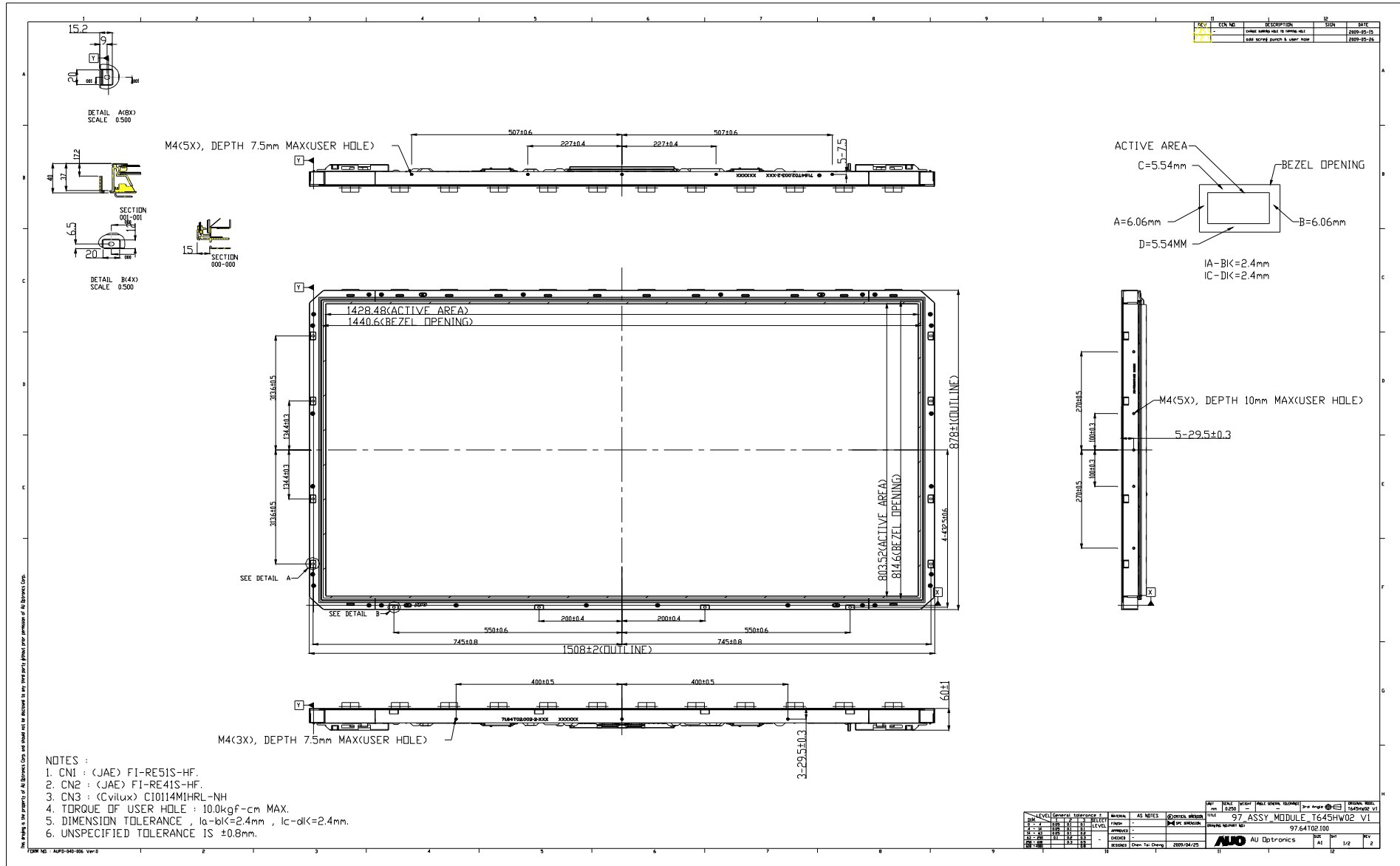

2D Drawing (Rear) - Draft

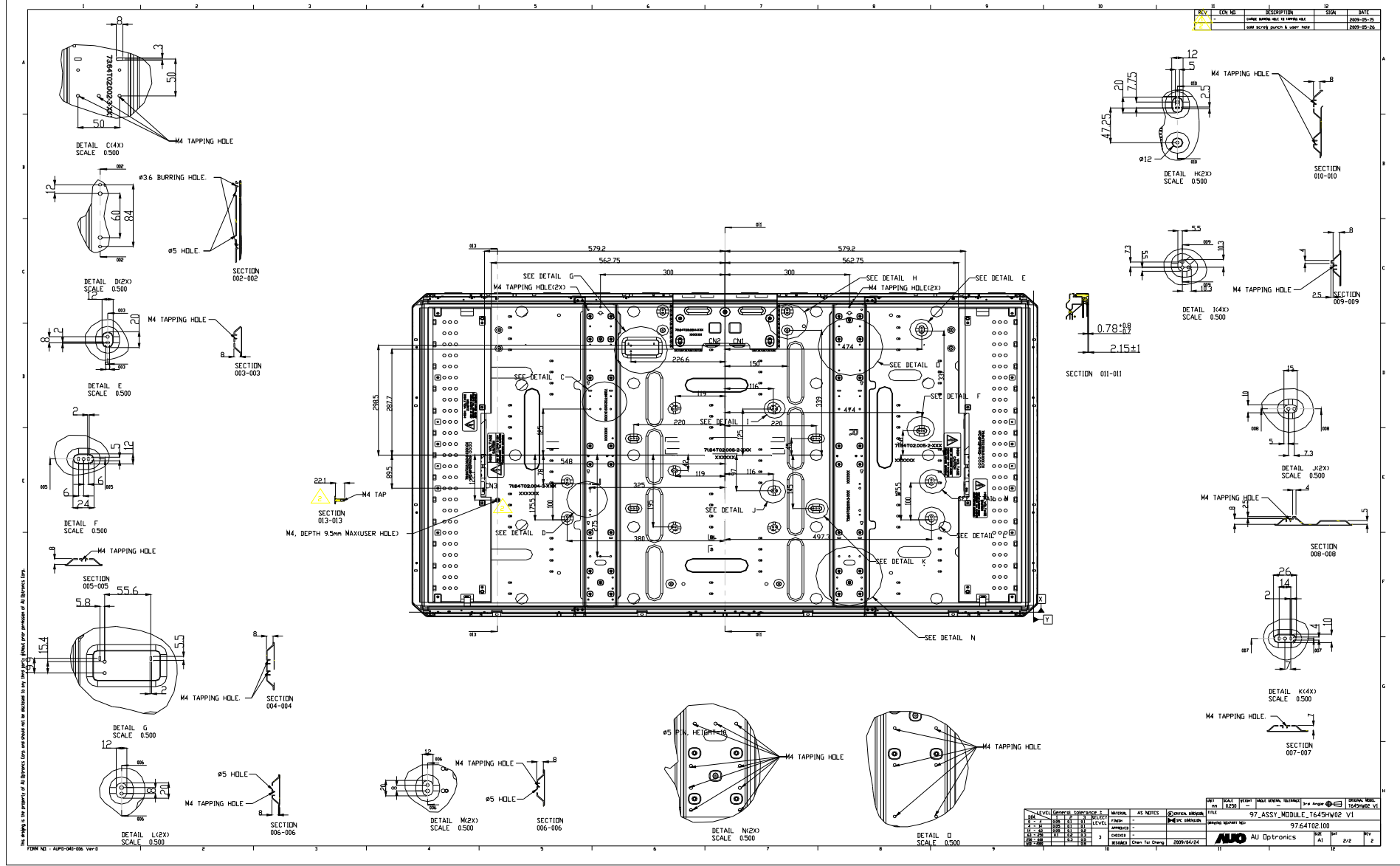

6. Packing

- A. Panel Label
- B. Carton Label
- C. Packing Instruction
- D. Packing Specification

[Packing information will be updated in next specification revision.]

7. Reliability Test

| No | Test Item | Q'ty | Condition |
|----|--|-------|---|
| 1 | High Temperature Storage | 3 pcs | Ta = 60°C, 300Hr Judge |
| 2 | Low Temperature Storage | 3 pcs | Ta = -20°C, 300Hr Judge |
| 3 | High Temperature Operation | 3 pcs | Ta = 50°C, 300Hr Judge |
| 4 | Low Temperature Operation | 3 pcs | Ta = -5°C , 300Hr Judge |
| 5 | Vibration Test (non-operating) [Note] | 3 pcs | Waveform: random Vibration Level: 1.5G RMS Bandwidth:10-300Hz Duration: 30min in each X, Y, Z direction |
| 6 | Shock Test (non-operating) [Note] | 3 pcs | Shock Level: 30G Waveform: sine wave, 11ms Direction: ±X, ±Y, ±Z one time each direction |
| 7 | Vibration Test (with carton) | 1 box | Waveform: random Vibration Level: 0.83G RMS Bandwidth:10-200Hz Duration: 30min in each X, Y, Z direction |
| 8 | Drop Test (with carton) | 1 box | Height: 31cm 1 corner, 3 edges, 6 surfaces (ASTMD5276 |

Note. Need to confirm the test criteria for ultra size panel with customer.

8. International Standard

8.1 Safety

- (1) UL1950 Third Edition, Underwriters Laboratories, Inc. Jan 28, 1995
Standard for safety of information technology equipment including electrical business equipment
- (2) CAN/CSA C22.2 No. 950-95 Third Edition, Canadian Standards Association
Standard for safety of information technology equipment including electrical business equipment
- (3) EN60950: 1992+A2: 1993+A2: 1993+C3: 1995+A4: 1997+A11: 1997
IEC 950: 1991+A1: 1992+A2: 1993+C3: 1995+A4:1996
European Committee for Electrotechnical Standardization (CENELEC)
European Standard for safety of information technology equipment including electrical business equipment

8.2 EMC

- (1) ANSI C63.4 "Methods of Measurement of Radio-Noise Emissions from Low-Voltage Electrical and Electrical Equipment in the Range of 9kHz to 40GHz. "American National standards Institute(ANSI), 1992
- (2) C.I.S.P.R "Limits and Methods of Measurement of Radio Interface Characteristics of Information Technology Equipment." International Special committee on Radio Interference.
- (3) EN 55022 "Limits and Methods of Measurement of Radio Interface Characteristics of Information Technology Equipment." European Committee for Electrotechnical Standardization. (CENELEC), 1998

9. Precautions

Please pay attention to the followings when you use this TFT LCD module.

9.1 MOUNTING PRECAUTIONS

- (1) You must mount a module using holes arranged on back or edge side of panel.
- (2) You should consider the mounting structure so that uneven force (ex. twisted stress) is not applied to module. And the case on which a module is mounted should have sufficient strength so that external force is not transmitted directly to the module.
- (3) Please attach the surface transparent protective plate to the surface in order to protect the polarizer. Transparent protective plate should have sufficient strength in order to resist external force.
- (4) You should adopt radiation structure to satisfy the temperature specification.
- (5) Acetic acid type and chlorine type materials for the cover case are not desirable because the former generates corrosive gas of attacking the polarizer at high temperature and the latter cause circuit break by electro-chemical reaction.
- (6) Do not touch, push or rub the exposed polarizer with glass, tweezers or anything harder than HB pencil lead. And please do not rub with dust clothes with chemical treatment. Do not touch the surface of polarizer for bare hand or greasy cloth. (Some cosmetics are detrimental to the polarizer.)
- (7) When the surface becomes dusty, please wipe gently with absorbent cotton or other soft materials like chamois soaks with petroleum benzene. Normal-hexane is recommended for cleaning the adhesives used to attach front/rear polarizer. Do not use acetone, toluene and alcohol because they cause chemical damage to the polarizer.
- (8) Wipe off saliva or water drops as soon as possible. Their long time contact with polarizer causes deformations and color fading.
- (9) Do not open the case because inside circuits do not have sufficient strength.
- (10) Due to heavy weight, please do not handle the panel by human without proper tooling for safety consideration.

9.2 OPERATING PRECAUTIONS

- (1) The device listed in this product specification sheets was designed and manufactured for TV application.
- (2) The spike noise causes the mis-operation of circuits. It should be lower than following voltage:
 $V = \pm 200\text{mV}$ (over and under shoot voltage)
- (3) Response time depends on the temperature. (In lower temperature, it becomes longer.)
- (4) Brightness of CCFL depends on the temperature. (In lower temperature, it becomes lower.) And in lower temperature, response time (required time that brightness is stable after turned on) becomes longer.
- (5) Be careful for condensation at sudden temperature change. Condensation makes damage to polarizer or electrical contacted parts. And after fading condensation, smear or spot will occur.
- (6) When fixed patterns are displayed for a long time, remnant image is likely to occur.

- (7) Module has high frequency circuits. Sufficient suppression to the electromagnetic interference shall be done by system manufacturers. Grounding and shielding methods may be important to minimize the interface.

9.3 ELECTROSTATIC DISCHARGE CONTROL

Since a module is composed of electronic circuits, it is not strong to electrostatic discharge. Make certain that treatment persons are connected to ground through wrist band etc. And don't touch interface pin directly.

9.4 PRECAUTIONS FOR STRONG LIGHT EXPOSURE

Strong light exposure causes degradation of polarizer and color filter.

9.5 STORAGE

When storing modules as spares for a long time, the following precautions are necessary.

- (1) Store them in a dark place. Do not expose the module to sunlight or fluorescent light. Keep the temperature between 5°C and 35°C at normal humidity.
- (2) The polarizer surface should not come in contact with any other object. It is recommended that they be stored in the container in which they were shipped.

9.6 HANDLING PRECAUTIONS FOR PROTECTION FILM

- (1) The protection film is attached to the bezel with a small masking tape. When the protection film is peeled off, static electricity is generated between the film and polarizer. This should be peeled off slowly and carefully by people who are electrically grounded and with well ion-blown equipment or in such a condition, etc.
- (2) When the module with protection film attached is stored for a long time, sometimes there remains a very small amount of flue still on the Bezel after the protection film is peeled off.
- (3) You can remove the glue easily. When the glue remains on the Bezel or its vestige is recognized, please wipe them off with absorbent cotton waste or other soft material like chamois soaked with normal-hexane.